

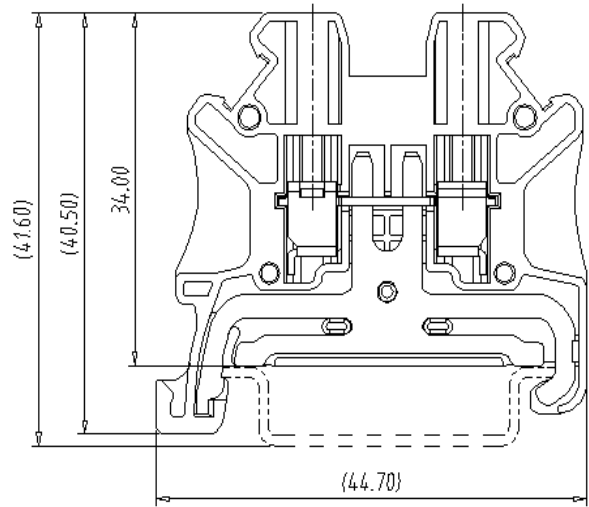

## Rail Mounted Terminal Block — TK series — TK2.5-T-PE

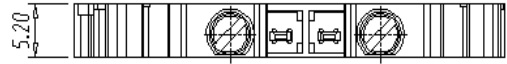

### ■ 图示(Pic. shown) : TK2.5-T-PE ( S )

General: Rail Mounted terminal block Rated: 1000V 2.5mm<sup>2</sup>  
Screw clamp unit: M2.5,0.4N·m  
Mounting type: DIN Rail TH35-7.5

认证 ( Approval ) 

### ■ 电路图(Circuit diagram)

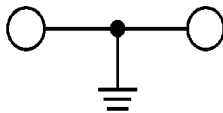

### ■ 尺寸(Dimensions)

长度(Length)	44.70mm
宽度(Width)	5.20mm
安装高度(Height TH35-7.5)	41.60mm

■ 技术参数 Technical Data	UL standard			IEC standard		
	UL Application group			IEC过电压别/污染等级(IEC overvoltage category /pollution degree)		
UL应用组别(UL Application group)	B	C	D	III / 3	III / 2	II / 2
IEC过电压别/污染等级(IEC overvoltage category /pollution degree)				1000V	--	--
额定电压(Rated voltage)	600V	600V	600V	--	--	--
额定电流(Rated current)	--	--	--	--	--	--
额定连接容量(Rated connection capacity)	26 ~ 12AWG			0.2 ~ 2.5mm <sup>2</sup> &4mm <sup>2</sup> (sol)		
刚性导线横截面 ( AWG ) ( Conductor cross section,solid )				26 ~ 12		
柔性导线横截面 ( AWG ) ( Conductor cross section,stranded )				26 ~ 12		
刚性导线横截面 ( mm <sup>2</sup> ) ( Conductor cross section,rigid )				0.2 ~ 4		
柔性导线横截面 ( mm <sup>2</sup> ) ( Conductor cross section,flexible )				0.2 ~ 2.5		
具有相同横截面的2根实心导线 ( mm <sup>2</sup> ) ( 2 conductors with cross section,solid )				0.2 ~ 1.5		
具有相同横截面的2根柔性导线 ( mm <sup>2</sup> ) ( 2 conductors with cross section,flexible )				0.2 ~ 1.5		
柔性导线横截面, 不带绝缘套管的冷压头 ( mm <sup>2</sup> ) ( Conductor cross section flexible , with ferrule without plastic sleeve )				0.2 ~ 2.5		
柔性导线横截面, 带绝缘套管的冷压头 ( mm <sup>2</sup> ) ( Conductor cross section flexible , with ferrule with plastic sleeve )				0.2 ~ 2.5		
2根具有相同横截面的导线, 柔性, 带TWIN套管及塑料套管 ( mm <sup>2</sup> ) ( 2 conductors with the same section flexible with TWIN ferrule and plastic sleeve )				0.5 ~ 1.5		
绝缘材料(Insulation Material)				PA66 UL94 V-0		
电流承载部件材料和镀层( Material & Plating of Current carrier )				Copper alloy , Tin plated		
接线螺丝(Wire clamp unit Screw) , 最大扭矩( torque Max. )				M2.5, 0.4N·m		
绝缘电阻(Insulation Resistance)				500MΩ or more at DC500V		
耐电压(1分钟)(Withstanding Voltage/1Min)				2200V		
额定冲击电压(Rated surge voltage)				8KV		
剥线长度(Wire stripping length)				9mm		
使用温度(Operating temperature)				-40°C up to +115°C		

## 订购方式(How to order)

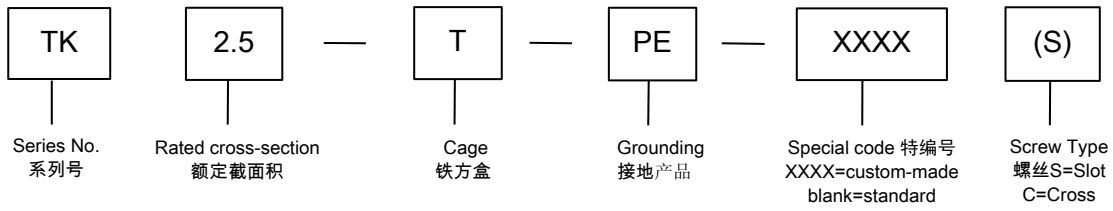

## Rail Terminal Block — TK series — TK2.5-T-PE—Accessories

### 安装导轨 DIN Rail



P/N:TH35-7.5-ST

P/N:TH35-7.5-AL

### 盖板 Cover P/N: TKC2.5-4-T

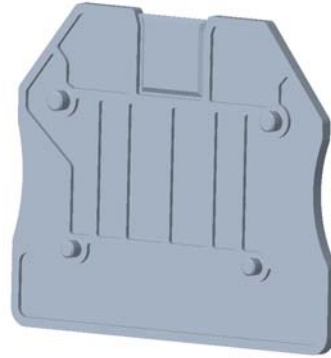

### 标示牌 Marking label P/N: MARK2.5DB-M

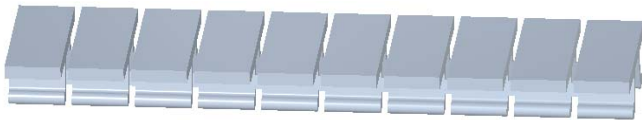

### 桥接件 Plug-in bridge P/N:/

### 终端固定器 End clamp



P/N: ETNS01



P/N: ETNS03



P/N: ETNS02